

BAOFENG

FM DUAL-BAND TRANSCEIVER WITH WIDE BAND COVERAGE

UV-5R USER'S MANUAL



FC CE 0678



This device is marked with the symbol on the selective sorting of waste electrical and electronic equipment. This means that this product, accessories and battery must be removed by a collection system under the European Directive 2002/96/EC either in order to be recycled or dismantled to reduce any impact on the environment. For more information, please contact your dealer, retailer or your local or regional level. Electronic products that have not been subject to potentially hazardous collection environmental and public health due to the possible presence of hazardous substances. Do not throw away packaging unusable domestic deposit them in containers for recycling.

PREFACE

Thank you for purchasing UV-5R Amateur Portable Radio, which is a dual band/dual display radio. This easy-to-use radio will deliver you secure, instant and reliable communications at peak efficiency. Please read this manual carefully before use. The information presented herein will help you to derive maximum performance from your radio.

SAFETY TRAINING INFORMATION



warning

Your UV-5R radio generates RF electromagnetic energy during transmit mode. This radio is designed for and classified as "Occupational Use Only", meaning it must be used only during the course of employment by individuals aware of the hazards, and the ways to minimize such hazards. This radio is NOT intended for use by the "General Population" in an uncontrolled environment.

This radio has been tested and complies with the FCC RF exposure limits for "Occupational Use Only". In addition, your UV-5R radio complies with the following Standards and Guidelines with regard to RF energy and electromagnetic energy levels and evaluation of such levels for exposure to humans:

- FCC OET Bulletin 65 Edition 97-01 Supplement C, Evaluating Compliance with FCC Guidelines for human Exposure to Radio Frequency Electromagnetic Fields.
- American Nation Standards Institute(C95.1-1992),IEEE Standard for Safety Levels with Respect to Human Exposure to Radio Frequency Electromagnetic Fields,3kHz to 300GHz.
- American Nation Standards Institute(C95.3-1992),IEEE Recommended Practice for the Measurement of Potentially Hazardous Electromagnetic Fields-RF and Microwave.
- The following accessories are authorized for use with this product.. Use of accessories other than those (listed in the instruction) specified may result in RF exposure levels exceeding the FCC requirements for wireless RF exposure.



caution

To ensure that your expose to RF electromagnetic energy is within the FCC allowable limits for occupational use, always adhere to the following guidelines:

- **DO NOT** operate the radio without a proper antenna attached, as this may damaged the radio and may also cause you to exceed FCC RF exposure limits. A proper antenna is the antenna supplied with this radio by the manufacturer or antenna specifically authorized by the manufacturer for use with this radio.
- **DO NOT** transmits for more than 50% of total radio use time ("50%duty cycle").Transmitting more than 50%of the time can cause FCC RF exposure compliance requirements to be exceed .The radio is transmitting when the "TX indicator" lights red .You can cause the radio to transmit by pressing the "PTT" switch .
- **ALWAYS** keep the antenna at least 60cm away from the body when transmitting.

The information listed above provides the user with the information needed to make him or her aware of RF exposure, and what to do to assure that this radio operates with the FCC RF exposure limits of this radio .

Electromagnetic Interference/Compatibility

During transmissions, your UV-5R radio generates RF energy that can possibly cause interference with other devices or systems .To avoid such interference, turn off the radio in areas where signs are posted to do so. **DO NOT** operate the transmitter in areas that are sensitive to electromagnetic radiation such as hospitals, aircraft, and blasting sites.

Occupational/Controlled Use

The radio transmitter is used in situations in which persons are exposed as consequence of their employment provided those persons are fully aware of the potential for exposure and can exercise control over their exposure.

The maximum duty cycle in VOX mode is 50%.

CONTENT

1.-SAFETY INFORMATION	03
2.-FEATURES AND FUNCTIONS	03
3.-UNPACKING AND CHECKING EQUIPMENTS	04
4.- OPTIONAL ACCESSORIES	04
5.- INSTALLATION OF ACCESSORIES	05
5.1.- INSTALLING THE ANTENNA	05
5.2.- INSTALLING THE BELT CLIP	05
5.3.- MICRO-HEADSET INSTALLATION OF EXTERNAL	05
5.4.- BATTERY INSTALLATION	05
6.-BATTERY CHARGING	06
7.-BATTERY INFORMATION	07
7.1.-INITIAL USE	07
7.2.-BATTERY TIPS	07
7.3.-PROLONG BATTERY LIFE	07
7.4.-BATTERY STORAGE	08
8.-PARTS, CONTROLS AND KEYS	08
8.1.-RADIO OVERVIEW	08
8.2.- COMMAND/KEY DEFINITION	09
9.-'LCD' DISPLAY	10
10.- 1750 Hz TONE FOR ACCESS TO REPEATERS	11
11.- BASIC OPERATION	11
11.1.-RADIO ON-OFF/VOLUME CONTROL	11
11.2.- SELECTING A FREQUENCY OR CHANNEL	11
12.-ADVANCED OPERATION	11
12.1.-SET MENU DESCRIPTION	11
12.2.-SHORTCUT MENU OPERATION	13
12.3.-"SQL" (SQUELCH)	13
12.4.-FUNCTION "VOX" (VOICE OPERATED TRANSMISSION)	13
12.5.- SELECT WIDEBAND OR NARROW BAND "W/N"	13
12.6.-TDR (DUAL WATCH/DUAL RECEPTION)	13
12.7.- TOT(TRANSMISSION TIMER)	14
12.8.-CTCSS/DCS	14
12.9.- ANI	14
12.10.- DTMFST (DTMF TONE OF TRANSMITTING CODE)	14
12.11.- SC-REV(SCAN RESUME METHOD)	14
12.12.- PTT-ID(PTT OR RELEASE PTT TO TRANSMIT THE SIGNAL CODE)	15
12.13.-BCL(BUSY CHANNEL LOCKOUT)	15
12.14.- SFT-D(DIRECTION OF FREQUENCY SHIFT)	15
12.15.- OFFSET(FREQUENCY SHIFT)	15
12.16.-STE(STE TAIL TONE ELIMINATION)	15
13.-CTCSS TABLE	15
14.-DCS TABLE	16
15.-TECHNICAL SPECIFICATION	16
15.1.-GENERAL	16
15.2.- TRANSMITTER	17
15.3.- RECEIVER	17
16.-TROUBLESHOOTING	18
17.-WARRANTY	19

1.-SAFETY INFORMATION:

The following safety precautions shall always be observed during operation, service and repair of this equipment.

- This equipment shall be serviced by qualified technicians only.
- Do not modify the radio for any reason.
- Use only BAOFENG supplied or approved batteries and chargers.
- Do not use any portable radio that has a damaged antenna. If a damaged antenna comes into contact with your skin, a minor burn can result.
- Turn off your radio prior to entering any area with explosive and flammable materials.
- Do not charge your battery in a location with explosive and flammable materials.
- To avoid electromagnetic interference and/or compatibility conflicts, turn off your radio in any area where posted notices instruct you to do so.
- Turn off your radio before boarding an aircraft. Any use of a radio must be in accordance with airline regulations or crew instructions.
- Turn off your radio before entering a blasting area.
- For vehicles with an air bag, do not place a radio in the area over an air bag or in the air bag deployment area.
- Do not expose the radio to direct sunlight over a long time, nor place it close to heating source.
- When transmitting with a portable radio, hold the radio in a vertical position with the microphone 3 to 4 centimeters away from your lips. Keep antenna at least 2.5 centimeters away from your body when transmitting.



WARNING: If you wear a radio on your body, ensure the radio and its antenna are at least 2.5 centimeters away from your body when transmitting.

2.-FEATURES AND FUNCTIONS:

- Dual-band handheld transceiver with display function menu on the display "LCD".
- DTMF encoded.
- Lithium-ion battery with high capacity.
- Commercial FM radio receiver (65 MHz ~ 108 MHz).
- Incorporates 105 codes "DCS" and 50 privacy codes "CTCSS" programmable.
- Function "VOX" (voice operated transmission).
- Alarm function.
- Up to 128 memory channels.
- Broadband (Wide) / Narrowband (Narrow), selectable.
- High power / low (4 W/1 W) selectable.
- Display illumination and programmable keyboard.
- Function "beep" on the keyboard.
- Dual Watch/dual reception .
- Selectable Frequency Step 12.5/25 kHz.
- Function "OFFSET" (frequency offset for repeater access).
- Battery saving function "SAVE".
- Timer transmission "TOT" programmable.
- Selecting the Scan Mode.
- Function Busy Channel Lock "BCLO".
- Built-in RX CTCSS/DCS scan
- Built-in LED flashlight.
- Programmable by PC.

- Level Threshold "Squelch" adjustable from 0 to 9.
- Crossband reception
- Tone end of transmission
- Built-in key lock

3.-UNPACKING AND CHECKING EQUIPMENTS:

Carefully unpack the transceiver. We recommend that you identify the items listed in the following before discarding the packing material. If any items are missing or have been damaged during shipment, please contact your dealers immediately.

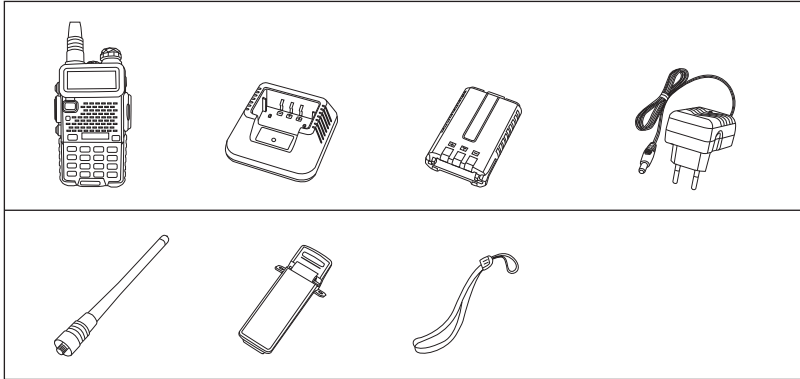

Note:

- Items included in the package, may differ from those listed in the table above depending on the country of purchase. For more information, consult your dealer or vendor.

4.- OPTIONAL ACCESSORIES:

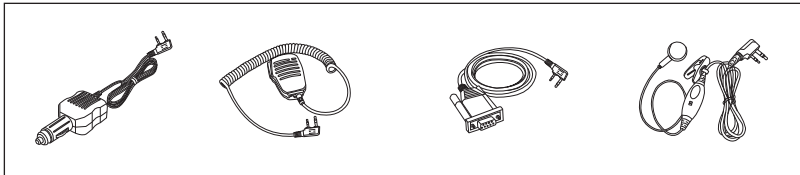

Note:

- Consult the dealer or retailer for information about options available.

5.- INSTALLATION OF ACCESSORIES:

5.1.- INSTALLING THE ANTENNA:

Install the antenna as shown in the figure below and turn it clockwise until it stops.

Note:

- When installing the antenna, don't rotate it by its top, holding it by its base and turn.
- If you use an external antenna, make sure the 'SWR' is about 1.5:1 or less, to avoid damage to the transceiver's final transistors.
- Do not hold the antenna with your hand or wrap the outside of it to avoid bad operation of the transceiver.
- Never transmit without an antenna.

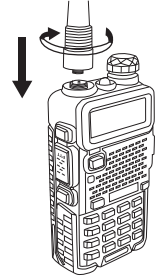

5.2.- INSTALLING THE BELT CLIP:

If necessary, install the belt clip at the rear of the battery compartment cover as shown in the figure below.

Note:

- Do not use any kind of glue to fix the screw on the belt clip. The solvents Glue may damage the battery casing.

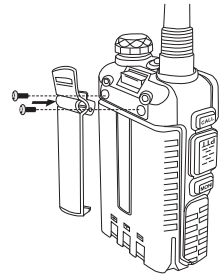

5.3.- MICRO-HEADSET INSTALLATION OF EXTERNAL:

Plug the external micro-headset connector into the jack of 'SP. & MIC' of the transceiver as shown in the figure below.

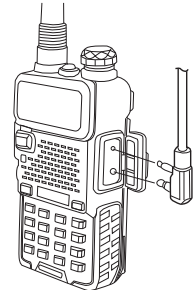

5.4.- BATTERY INSTALLATION:

- When attaching the battery, make sure the battery is in parallel and in good contact with the aluminum chassis. The battery bottom is about 1 to 2 centimeters below the bottom of the radio's body.
- Align the battery with the guide rails on the aluminum chassis and slide it upwards until a 'click' is heard.
- The battery latch at the bottom locks the battery.

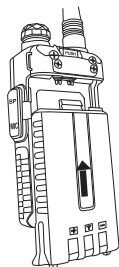

-Turn off the radio before removing the battery.

- Slide the battery latch, at the bottom of the radio's body, in the direction indicated by the arrow.
- Slide down the battery for about 1 to 2 centimeters, and then remove the battery from the radio's body.

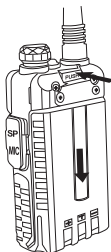

6.-BATTERY CHARGING:

Use only the charger specified by the manufacturer. The charger's LED indicates the charging progress.

CHARGING STATUS	LED INDICATION
Standby (no-load)	Red LED flashes, while Green LED glows
Charging	Red LED solidly glows
Fully Charged	Green LED solidly glows
Error	Red LED flashes, while Green LED glows



Please follow these steps:

1. Plug the power cord into the adapter.
2. Plug the AC connector of the adapter into the AC outlet socket.
3. Plug the DC connector of the adapter into the DC socket on the back of the charger.
4. Place the radio with the battery attached, or the battery alone, in the charger.
5. Make sure the battery is in good contact with the charging terminals. The charging process initiates when the red LED lights.
6. The green LED lights about 4 hours later indicating the battery is fully charged. Then remove the radio with the battery attached or the battery alone from the charger.

7.-BATTERY INFORMATION:

7.1.-INITIAL USE

New batteries are shipped uncharged fully from the factory. Charge a new battery for 5 hours before initial use. The maximum battery capacity and performance is achieved after three full charge/discharge cycles. If you notice the battery power runs low, please recharge the battery.



WARNING: -To reduce the risk of injury, charge only the battery specified by the manufacturer. Other batteries may burst, causing bodily injury and property damage.
-To avoid risk of personal injury, do not dispose of batteries in a fire!

- Dispose of batteries according to local regulations (e.g. recycling). Do not dispose as household waste.
- Never attempt to disassemble the battery.

7.2.-BATTERY TIPS:

1. When charging your battery, keep it at a temperature among 5°C - 40°C. Temperature out of the limit may cause battery leakage or damage.
2. When charging a battery attached to a radio, turn the radio off to ensure a full charge.
3. Do not cut off the power supply or remove the battery when charging a battery.
4. Never charge a battery that is wet. Please dry it with a soft cloth prior to charge.
5. The battery will eventually wear out. When the operating time (talk-time and standby time) is noticeably shorter than normal performance, it is time to buy a new battery.

7.3.-PROLONG BATTERY LIFE:

1. Battery performance will be greatly decreased at a temperature below 0°C. A spare battery is necessary in cold weather. The cold battery unable to work in this situation may work under room temperature, so keep it for later use.

2. The dust on the battery contact may cause the battery cannot work or charge. Please use a clean dry cloth to wipe it before attaching the battery to the radio.

7.4.-BATTERY STORAGE:

1. Fully charge a battery before you store it for a long time, to avoid battery damage due to over-discharge.
2. Recharge a battery after several months' storage (Li-Ion batteries: 6 months), to avoid battery capacity reduction due to over-discharge.
3. Store your battery in a cool and dry place under room temperature, to reduce self-discharge.

8.-PARTS, CONTROLS AND KEYS:

8.1.-RADIO OVERVIEW:

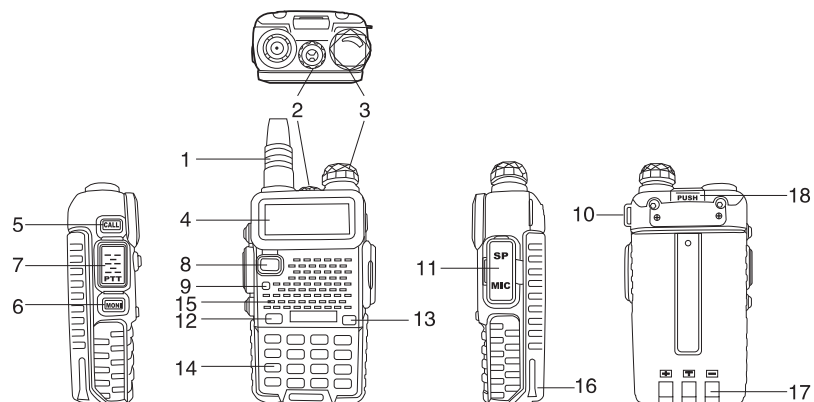

1. antenna	10. strap buckle
2. flashlight	11.accessory jack
3. knob (ON/OFF,volume)	12.A/B key(frequency display switches)
4. LCD	13.BAND key(band switches)
5. SK-side key1/CALL(radio,alarm)	14.keypad
6. SK-side key2/MONI(flashlight,monitor)	15.SP.&MIC.
7. PTT key(push-to-talk)	16.battery pack
8. VFO/MR (frequency mode/channel mode)	17.battery contacts
9. LED indicator	18.battery remove button

8.2.- COMMAND/KEY DEFINITION:

► [PTT](PUSH-TO-TALK):

Press and hold down the [PTT] button to transmit; release it to receive.

► SK-SIDE KEY1/[CALL]:

- Press the [CALL] button, to activate the FM Radio; Press it again to deactivate the FM Radio.
- Press and hold on the [CALL] button, to activate the alarm function; Press and hold it again, to deactivate the alarm function.

► SK-SIDE KEY2/[MONI]:

- Press the [MONI] button, to turn on the flashlight; Press it again to turn off. Press and hold on the [MONI] button, to monitor the signal.

► [VFO/MR]BUTTON:

- Press the [VFO/MR] button, to switch the frequency mode and channel mode.

► [A/B]BUTTON:

- Press the [A/B] button, to switch frequency display.

► [BAND]BUTTON:

- Press the [BAND] button, to switch band display.
- While FM radio being activated, press the [BAND] button to switch the band of FM radio (band 65-75MHz/76-108MHz).

► [*SCAN]KEY:

- Press the [*SCAN] key to activate the Reverse function, it will exchange a separate reception and transmission frequency.
- Press the [*SCAN] key for 2 seconds to start scanning (frequency/channel).
- While FM radio being activated, press the [*SCAN] key to search FM radio station.
- While setting the RX CTCSS/DCS, press the key [*SCAN] to scan the RX CTCSS/DCS.

► [# r] KEY:

- Under channel mode, press [# r] key to switch High/Low transmit power.
- Press [# r] key for 2 seconds to lock/unlock the keypad.

► FUNCTION KEYPAD:

- [MENU] key:
- To enter the menu of the radio and confirm the setting.
- [▲] [▼] key:
- Press and hold [▲] or [▼] key for frequency up or down fast.
- Press [▲] or [▼] key, the scanning will be opposite.
- [EXIT] key:
- To cancel /clear or exit.

► NUMERIC KEYPAD:

- Used to enter information for programming the radio's lists and the non-standard CTCSS
- Under transmission mode, press the numeric key to send the signal code (the code should be set by PC software).



► **ACCESSORY JACK:**

-The jack is used to connect audio accessories, or other accessories such as programming cable.

9.-'LCD' DISPLAY:

The display icons appear when certain operations or specific features are activated.

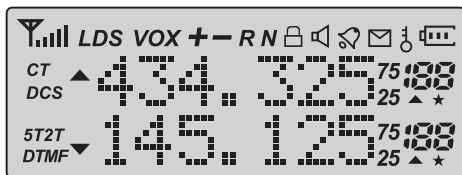

Icon	Description
	Operating channel.
	Operating frequency.
CT	'CTCSS' activated.
DCS	'DCS' activated.
+ -	Frequency offset direction for accessing repeaters.
S	Dual Watch/Dual Reception functions activated.
VOX	Function 'VOX' enabled.
R	Reverse function activated.
N	Wide Band selected.
	Battery Level indicator
	Keypad lock function activated.
L	Low transmit power.
	Operation frequency.
	Signal Strength Level.

10.- 1750 Hz TONE FOR ACCESS TO REPEATERS:

The user needs to establish long distance communications through an amateur radio repeater which is activated after receiving a 1750 Hz tone. Press and hold on the [PTT], then press the [BAND] button to transmit a 1750Hz tone.

11.- BASIC OPERATION:

11.1.-RADIO ON-OFF/VOLUME CONTROL :

-Make sure the antenna and battery are installed correctly and the battery charged.
 -Rotate the knob clockwise to turn the radio on, and rotate the knob fully counter-clockwise until a 'click' is heard to turn the radio off. Turn the knob clockwise to increase the volume, or counter-clockwise to decrease the volume.

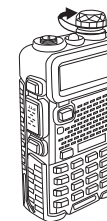

11.2.- SELECTING A FREQUENCY OR CHANNEL:

-Press the key [▲] or [▼] to select the desired frequency/channel you want. The display shows the frequency / channel selected.
 -Press and hold down the key [▲] or [▼] for frequency up or down fast.

Note:

- You can not select a channel if not previously stored.

12-ADVANCED OPERATION:

You can program your transceiver operating in the setup menu to suit your needs or preferences.

12.1.-SET MENU DESCRIPTION:

Menu	Function/Description	Available settings
0	SQL (Squelch level)	0-9
1	STEP(Frequency step)	2.5/5/6.25/10/12.5/25kHz
2	TXP(Transmit power)	HIGH/LOW
3	SAVE(Battery save,1:1/1:2/1:3/1:4)	OFF/1/2/3/4
4	VOX(Voice operated transmission)	OFF/0-10
5	W/N(Wideband/narrowband)	WIDE/NARR
6	ABR(Display illumination)	OFF/1/2/3/4/5s
7	TDR(Dual watch/dual reception)	OFF/ON

8	BEEP(Keypad beep)	OFF/ON
9	TOT(Transmission timer)	15/30/45/60.../585/600seconds
10	R-DCS(Reception digital coded squelch)	OFF/D023N...D754I
11	R-CTS(Reception Continuous Tone Coded Squelch)	67.0Hz...254.1Hz
12	T-DCS(Transmission digital coded squelch)	OFF/D023N...D754I
13	T-CTS(Transmission Continuous Tone Coded Squelch)	67.0Hz...254.1Hz
14	VOICE(Voice prompt)	OFF/ON
15	ANI(Automatic number identification of the radio,only can be set by PC software.	
16	DTMFST(The DTMF tone of transmitting code.)	OFF/DT-ST/ANI-ST/DT+ANI
17	S-CODE(Signal code, only could be set by PC software.)	1,...,15 groups
18	SC-REV(Scan resume method)	TO/CO/SE
19	PTT-ID(press or release the PTT button to transmit the signal code)	OFF/BOT/EOT/BOTH
20	PTT-LT(delay the signal code sending)	0,...,30ms
21	MDF-A(under channel mode, A channel displays. Note: name display only can be set by PC software.	FREQ/CH/NAME
22	MDF-B(under channel mode, B channel displays. Note: name display only can be set by PC software.	FREQ/CH/NAME
23	BCL(busy channel lockout)	OFF/ON
24	AUTOLK(keypad locked automatically)	OFF/ON
25	SFT-D(direction of frequency shift)	OFF/+/-
26	OFFSET(frequency shift)	00.000...69.990
27	MEMCH(stored in memory channels)	000, ...127
28	DELCH(delete the memory channels)	000, ...127
29	WT-LED(illumination display color of standby)	OFF/BLUE/ORANGE/PURPLE
30	RX-LED(illumination display color of reception)	OFF/BLUE/ORANGE/PURPLE
31	TX-LED(illumination display color of transmitting)	OFF/BLUE/ORANGE/PURPLE
32	AL-MOD(alarm mode)	SITE/TONE/CODE
33	BAND(band selection)	VHF/UHF
34	TX-AB(transmitting selection while in dual watch/ reception)	OFF/A/B
35	STE(Tail Tone Elimination)	OFF/ON

36	RP_STE(Tail tone elimination in communication through repeater)	OFF/1,2,3...10
37	RPT_RL(Delay the tail tone of repeater)	OFF/1,2,3...10
38	PONMGS(Boot display)	FULL/MGS
39	ROGER(tone end of transmission)	ON/OFF
40	RESET (Restore to default setting)	VFO/ALL

12.2.-SHORTCUT MENU OPERATION:

- 1.-Press the key MENU,then press the key ▲ or ▼ to select the desired menu.
- 2.-Press the key MENU again, come to the parameter setting.
- 3.-Press the key ▲ or ▼ to select the desired parameter.
- 4.-Press the key MENU to confirm and save, press the key EXIT to cancel setting or clear the input.

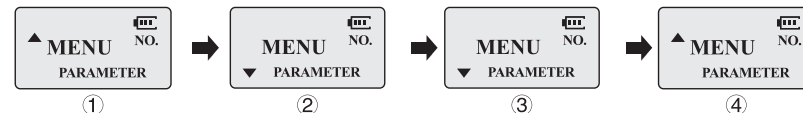

-Note:

- 1.Under channel mode,the following menu settings are invalid:CTCSS,DCS,W/N,PTT-ID,BCL,SCAN ADD TO,S-CODE,CHANNEL NAME.Only the H/L power could be changed.
- 2.OFFSET frequency(TX/RX) could be stored in same channel,please come to MENU 27 to set,first confirmation to set RX,second confirmation to set TX.**

12.3.-"SQL" (SQUELCH):

-The squelch mute the speaker of the transceiver in the absence of reception. With the squelch level correctly set, you will hear sound only while actually receiving signals and significantly reduces battery current consumption. It is recommended that you set Level 5.

12.4.- FUNCTION "VOX" (VOICE OPERATED TRANSMISSION):

-This function is not necessary to push the [PTT] on the transceiver for a transmission. Transmission is activated automatically by detecting the radio voice. When finish speaking, the transmission automatically terminated and the transceiver will automatically receive signal. Be sure to adjust the VOX Gain level to an appropriate sensitivity to allow smooth transmission.

12.5.- SELECT WIDEBAND OR NARROW BAND "W/N":

In areas where the RF signals are saturated, you must use the narrow band of transmission to avoid interference in adjacent channels.

12.6.- TDR (DUAL WATCH/DUAL RECEPTION):

This feature allows you to operate between frequency A and frequency B. Periodically, the transceiver checks whether a signal is received on another frequency that we have scheduled. If you receive a signal, the unit will remain in the frequency until the received signal disappears.

12.7.-TOT(TRANSMISSION TIMER):

This function can automatically control the time we transmit each time you press [PTT] on the transceiver. This feature is very useful to avoid overheating excessive power transistors of the transceiver. The transceiver will be off transmission automatically once the set time.

12.8.-CTCSS/DCS:

In some cases only want to establish communications in a closed user group at a particular frequency or channel, for it will use "CTCSS" or code "DCS" for reception.

The "squelch" opens only when receiving a frequency with "CTCSS" or codes "DCS" same as the programmed in your transceiver. If codes of the received signal differs from those programmed in your transceiver, the "squelch" will not open and the received signal can be heard.

Note:

- The use of "CTCSS" or "DCS" in a communication, does not guarantee complete confidentiality communication.

12.9.- ANI

-ANI (Automatic Number Identification) is also known as PTT ID because an ID is transmitted when the PTT button of the radio is pressed and/or released. This ID tells the dispatcher which field radio was keyed.

Only could be set by PC software.

12.10.- DTMFST (DTMF TONE OF TRANSMITTING CODE):

First you should set the PTT-ID as BOT/EOT/BOTH

- "OFF"-Under transmitting mode, you can't hear the DTMF tone, while you press the key to transmit the code or code automatically transmitted.

- "DT-ST"-Under transmitting mode, you can hear the DTMF tone, while you press the key to transmit the code.

- "ANI-ST"-under transmitting mode, you can hear the DTMF tone, while the code automatically transmitted.

- "DT-ANI"-under transmitting mode, you can hear the DTMF tone, while you press the key to transmit the code or the code automatically transmitted.

12.11.- SC-REV(SCAN RESUME METHOD):

This transceiver allows you to scan memory channels, all the bands or part of the bands. When the transceiver detects a communication, the scan will stop automatically.

Notes:

- "TO" (Time Operation):

Scanning will stop when it detects an active signal. The scanning will stop on each channel or active frequency for a predetermined time, after that time the scan will resume automatically.

- "CO" (Carrier Operation):

The scanning will stop and remain in the frequency or channel, until the active signal disappears.

- "SE"(Search Operation):

The scanning will stop and remain in the frequency or channel after it detects an active signal.

12.12.- PTT-ID(PTT OR RELEASE PTT TO TRANSMIT THE SIGNAL CODE):

-This feature allows you to know who call you.

- "OFF"-Don't transmit the code while push the PTT button.

- "BOT"-Transmit the code while push the PTT button.(the code only could be set by PC software.)

- "EOT"-Transmit the code while release the PTT button.

- "BOTH"-Transmit the code while push or release the PTT button.

12.13.- BCL(BUSY CHANNEL LOCKOUT):

The BCLO feature prevents the radio's transmitter from being activated if a signal strong enough to break through the "noise" squelch is present. On a frequency where stations using different CTCSS or DCS codes may be active, BCLO prevents you from disrupting their communications accidentally (because your radio may be muted by its own tone decoder).

12.14.- SFT-D(DIRECTION OF FREQUENCY SHIFT):

The "OFFSET" is the difference or offset between the reception frequency and the frequency of transmission for access to amateur radio repeaters. Set the "OFFSET" according to the "OFFSET" amateur radio repeater through which want to communicate.

12.15.- OFFSET(FREQUENCY SHIFT):

When communicating via a repeater, the direction of displacement of frequency should be timed to the displacement of the transmission frequency is higher or lower than the receiving frequency. example:

If we want to make a communication through amateur radio repeater whose frequency input is 145,000 MHz and 145,600 MHz is output, we select the "OFFSET" of the previous section in 0600 and the direction of travel "SHIFT" programmed to [-], so the transceiver will always 145,600 MHz in frequency and when you press [PTT] to transmit transceiver, the frequency will automatically move to 145,000 MHz

12.16.-STE (TAIL TONE ELIMINATION):

This function is used to activate or deactivate the transmission end of the transceiver. this final tone transmission only be used in communications between transceivers and not in communications through a repeater, which must be deactivated.

13.-CTCSS TABLE:

Nº	Tone(Hz)	Nº	Tone(Hz)	Nº	Tone(Hz)	Nº	Tone(Hz)	Nº	Tone(Hz)
1	67.0	11	94.8	21	131.8	31	171.3	41	203.5
2	69.3	12	97.4	22	136.5	32	173.8	42	206.5
3	71.9	13	100.0	23	141.3	33	177.3	43	210.7
4	74.4	14	103.5	24	146.2	34	179.9	44	218.1
5	77.0	15	107.2	25	151.4	35	183.5	45	225.7
6	79.7	16	110.9	26	156.7	36	186.2	46	229.1
7	82.5	17	114.8	27	159.8	37	189.9	47	233.6
8	85.4	18	118.8	28	162.2	38	192.8	48	241.8
9	88.5	19	123.0	29	165.5	39	196.6	49	250.3
10	91.5	20	127.3	30	167.9	40	199.5	50	254.1

14.-DCS TABLE:

N°	Code	N°	Code	N°	Code	N°	Code	N°	Code
1	D023N	22	D131N	43	D251N	64	D371N	85	D532N
2	D025N	23	D132N	44	D252N	65	D411N	86	D546N
3	D026N	24	D134N	45	D255N	66	D412N	87	D565N
4	D031N	25	D143N	46	D261N	67	D413N	88	D606N
5	D032N	26	D145N	47	D263N	68	D423N	89	D612N
6	D036N	27	D152N	48	D265N	69	D431N	90	D624N
7	D043N	28	D155N	49	D266N	70	D432N	91	D627N
8	D047N	29	D156N	50	D271N	71	D445N	92	D631N
9	D051N	30	D162N	51	D274N	72	D446N	93	D632N
10	D053N	31	D165N	52	D306N	73	D452N	94	D645N
11	D054N	32	D172N	53	D311N	74	D454N	95	D654N
12	D065N	33	D174N	54	D315N	75	D455N	96	D662N
13	D071N	34	D205N	55	D325N	76	D462N	97	D664N
14	D072N	35	D212N	56	D331N	77	D464N	98	D703N
15	D073N	36	D223N	57	D332N	78	D465N	99	D712N
16	D074N	37	D225N	58	D343N	79	D466N	100	D723N
17	D114N	38	D226N	59	D346N	80	D503N	101	D731N
18	D115N	39	D243N	60	D351N	81	D506N	102	D732N
19	D116N	40	D244N	61	D356N	82	D516N	103	D734N
20	D122N	41	D245N	62	D364N	83	D523N	104	D743N
21	D125N	42	D246N	63	D365N	84	D526N	105	D754N

15.-TECHNICAL SPECIFICATION:**15.1.-GENERAL:**

Frequency range	65MHz-108MHz(Only commercial FM radio reception) VHF:144MHz-146MHz (Rx/Tx),UHF:430MHz-440MHz (Rx/Tx)
Memory channels	Up to 128 channels
Frequency stability	2.5ppm
Frequency step	12.5kHz/25kHz
Antenna impedance	50 Ω
Operating temperature	-20 °C to +60 °C
Supply voltage	Rechargeable Lithium-Ion mAh 7.4V/1800
Consumption in standby	≤ 75mA
Consumption in reception	380mA
Consumption in transmission	≤ 1.4 A
Mode of operation	Simplex or semi-duplex
Duty cycle	03/03/54 min. (Rx / Tx / Standby)
Dimensions	58mm x 110mm x 32mm
Weight	130 g (approximate)

15.2. - TRANSMITTER:

RF power	4W
Type of modulation	FM
Emission class	16K Φ F3E/11K Φ F3E (W/N)
Maximum deviation	≤ ± 5 kHz/≤ ± 2.5 kHz (W/N)
Spurious emissions	<-60 dB

15.3. - RECEIVER:

Receiver sensitivity	0.2 μ V(at 12 dB SINAD)
Intermodulation	60 dB
Audio output	1000mW
Adjacent channel selectivity	65/60dB

Note:

- All specifications shown are subject to change without notice.

16.-TROUBLESHOOTING:

Problem	Possible cause / solution
The radio does not start.	The battery is low, replace the battery with a charged battery or proceed to the battery. The battery is not installed correctly, remove the battery and reattach it.
The battery runs down quickly.	The battery life has come to an end, replace the battery with a new one. The battery is fully charged, make sure the battery is made in full.
The receiving indicator LED lights but do not hear the speaker.	Make sure the volume setting is too low. Make sure the undertones "CTCSS" or code "DCS" are the same as those programmed in the transceiver of the other members of your group.
When transmitting, the other members of his group do not receive the communication.	Make sure the undertones "CTCSS" or code "DCS" programmed in your transceiver are the same as those programmed in the transceiver of the other members of your group. Your partner or you, are too far. You or your partner are in a bad area of RF signal propagation.
In "standby" mode, the transceiver transmits without pressing the "PTT".	Check the level adjustment function "VOX" is not set too sensitive.
Receive communications from other user groups while communicating with your group.	Change frequency or channel. Change the undertones "CTCSS" or code "DCS" in your group.
Communication with other members of your group is poor or low quality.	You or your partner is too far away or in an area of poor radio signal propagation, such as inside a tunnel, inside an underground car park, in a mountainous area, including large metal structures, etc..
Once these checks, if you still have problems with the transceiver, check with your distributor, dealer or service center.	

17.-WARRANTY: (Better buy the radios from local dealer).

WARRANTY CERTIFICATE		
Brand:	Model no.:	Serial no.:
Name of purchaser:		
Address:		
City:	Zip code:	Seal and name of the dealer:
Province/State:	Tel no.:	
Date of purchase:		
WARNING: Warranty is valid provided it is complete and properly filled in legibly and clearly present the seal and name of the dealer and have attached the bill proof of purchase of equipment.		

The device described in this Certificate is guaranteed for a period of one year from the date of sale to the final user. This Warranty Certificate is unique and not transferable and may not be reissued for new or original or copy. Substitution of product failure or any part thereof shall not involve extension of the guarantee.

The warranty covers the replacement and free replacement of all parts that are defective in materials and components used in manufacturing and / or assembly of the apparatus.

The warranty does not cover any faults caused by accident, improper installation and use, electric shock (eg storms), connect a power other than that specified, reverse polarity in the diet, or claims due to deterioration in the external appearance of normal use, nor the amount or condition of the accessories.

Checking the accessories is the responsibility of the purchaser at the time of purchasing the device.

The warranty does not cover rechargeable batteries even if they are part of the equipment purchased as they are considered consumables, the impairment must be reported within a period of fifteen days from the date of purchase.

The warranty is void on the following assumptions:

1. - Devices that have been manipulated by another or by anyone other than authorized service provider.
2. - Equipment and accessories in which the serial number has been altered, deleted or filed unreadable.
3. - Use of the product than as intended.

To make use of the guarantee is necessary to give the dealer or any of the Authorised Service the defective device with its accessories and the following documentation:

1. - Warranty Certificate duly completed and sealed.
2. - Original invoice which clearly identifies the device and the date of purchase.
3. - Description of the faults.

The warranty terms contained in this Certificate of Guarantee do not exclude, modify or restrict the statutory rights of the buyer by virtue of the laws in force at the time of purchase, but are added to them.

DECLARATION OF CONFORMITY

We, FUJIAN NAN'AN BAOFENG ELECTRONICS CO.,LTD. (Address as Changfu Industrial Zone, Xiamei, Nan'an, Quanzhou, Fujian, China.) hereby declare our product:

Product Name: Two Way Radio

Brand Name: BAOFENG

Model Number: UV-5R

is in compliance with the essential requirements and other relevant provisions of the R&TTE 2006/95/EC, 2004/108/EC and 99/5/EC, and carries the CE mark accordingly.

Supplementary information:

The product complies with the requirements of:

EN60950-1:2006+A11:2009; EN50332-1:2000

ETSI EN 301 783-1 V1.3.1 (2008-09); ETSI EN 301 783-2 V1.2.1 (2008-09)

ETSI EN 301 489-1 V1.8.1 (2008-04); ETSI EN 301 489-5 V1.3.1 (2002-08)

Date: March 9,2012

Signature: WANG SHAO FENG

FUJIAN NAN'AN BAOFENG ELECTRONICS CO.,LTD.

CHANGFU INDUSTRIAL ZONE, XIAMEI, NAN'AN, QUANZHOU, FUJIAN, CHINA

TEL:+86-595-86752889/86767889 FAX:+86-595-86753889

E-Mail:baofeng@263.net <http://www.powerphone.com.cn>